

MODEL V74HD CUSTOMER ORDER FORM



REV6012010

PAGE 1

Bill To	
Company:	
(Legal Name)	
Address:	
Address:	
City/State/Zip:	
Attention:	
Phone:	
Fax:	

Ship To	
Company:	
Address:	
Address:	
City/State/Zip:	
Attention:	
Phone:	
Fax:	

Select HP/Voltage & Electrical Requirements:



	Motor HP	Voltage	Full Load Amps	Power Supply Required
<input type="checkbox"/>	15HP 3 Phase	208V	46	80
<input type="checkbox"/>	15HP 3 Phase	230V	41	80
<input type="checkbox"/>	15HP 3 Phase	460/480V	20	40

CUSTOMER IS REQUIRED TO SUPPLY A FUSED DISCONNECT AND 12' PIGTAIL

Door Swing: (drawing shows LEFT HAND layout (based on side of hinge when facing the baler))

- LEFT Hand Hinge
- RIGHT Hand Hinge

Options:

- Slotted Door
- Single Phase Power Unit
- Rear Wire Guides
- Full Bale Light
- Custom Logo
- Custom Color
- Rear Feed Front Eject
- Front Feed Chute
- Floppy Retainer Dogs
- Oil Heater
- Weather Proof (outdoor use)

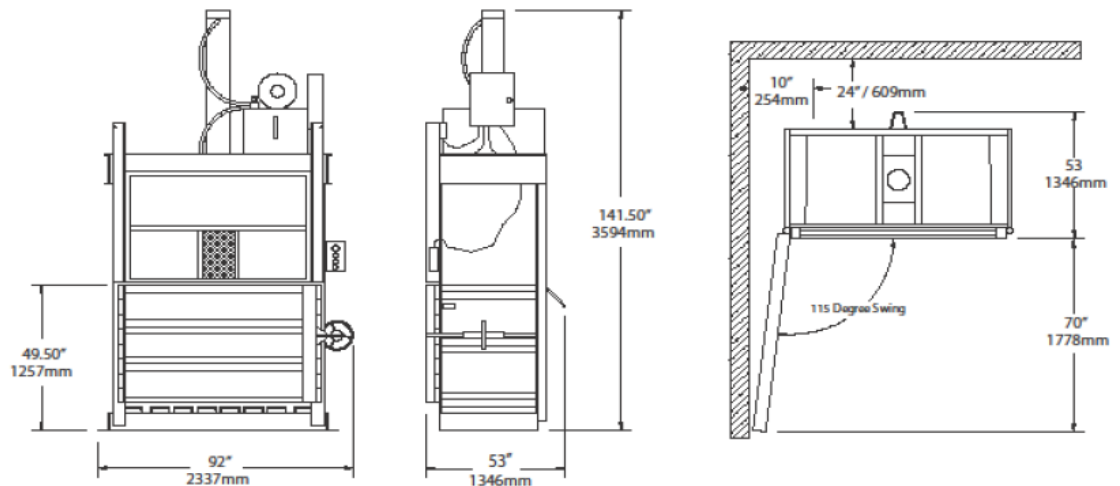

NOTES:

Color: Grey Green Blue Custom Color (CODE) _____

Delivery:

What is your required delivery date? _____

Do you require BACE to deliver? YES NO

Installation: If you require BACE to set up installation please fill out PAGE 2 of this document.

Signature _____ Date _____ PO # _____

In order to process your order we must receive a signed copy of this document along with a signed copy of the Estimate from BACE for this job. Please fax to: (704) 394-2210 or email to sales@bacecorp.com

INSTALLATION FORM

Installation: If you require BACE to set up installation please completely fill out this document.

Preferred Installer:	
Company:	
Address:	
Address:	
City/State/Zip:	
Attention:	
Phone:	
Fax:	

	YES	NO
Do you have a loading dock with 8' wide door?		
What is your ceiling height?		
Any obstacles (steps, grade change, overhead pipes)?		
Do we need to remove an existing baler?		
Do you have a forklift onsite?		
What is the capacity of your forklift?	LBS	

Provide a diagram for the proposed location of the baler similar to the drawing shown below.

